

SAFETY PRECAUTIONS

DEFINITION

The instructions to be followed are classified by the following symbols:



This symbol denotes an action that is **PROHIBITED**.



These symbols denote actions that are **COMPULSORY**.

To prevent personal injury, injury to others, or property damage, please observe the following.

Incorrect operation due to failure to follow instructions may cause harm or damage, the seriousness of which is classified as below:



Warning This sign warns of death or serious injury.



Caution This sign warns of injury or damage to property.

Remote Control



- Do not use rechargeable (Ni-Cd) batteries.
- Do not allow infants and small children to play with the remote control to prevent them from accidentally swallowing the batteries.



- Remove the batteries if the unit is not going to be used for a long period of time.
- New batteries of the same type must be inserted following the polarity stated to prevent malfunction of the remote control.

Indoor Unit



- Do not install, remove and reinstall the unit by yourself; improper installation will cause leakage, electric shock or fire. Please consult an authorized dealer or specialist for the installation work.
- Do not insert your fingers or other objects into the unit.
- Do not attempt to repair the unit by yourself.

Indoor Unit



- Do not install the unit in a potentially explosive atmosphere.
- Do not wash the unit with water, benzene, thinner or scouring powder.
- Do not use for other purposes such as preservation of food.
- Do not use any combustible equipment in front of the airflow outlet.
- Do not expose directly to cold air for a long period.
- Ensure that the drainage pipe is connected properly. Otherwise, leakage may occur.
- Aerate the room regularly.



Power Supply



- Do not share the same power outlet with other equipment.
- Do not modify power cords.
- Do not use extension cords.
- Do not operate with wet hands.
- Do not operate or stop the unit by inserting or pulling out the power plug.
- Insert the power plug properly.
- Use the specified supply cord.
- If the supply cord is damaged, it must be replaced by the manufacturer, its service agent or similarly qualified persons in order to avoid a hazard.



- Dust on the electric power plug should be periodically wiped with a dry cloth.



- This equipment must be earthed and strongly recommended to be installed with Earth Leakage Circuit Breaker (ELCB) or Residual Current Device (RCD). Otherwise, it may cause electrical shock or fire in case of malfunction.



- In case of emergency or abnormal conditions (burnt smell, etc), turn off the power supply and unplug, and consult your nearest dealer.



Outdoor Unit



- Do not insert your fingers or other objects into the unit.

Power Supply



- Do not pull the cord to disconnect the plug.



- Switch off the power supply and unplug before cleaning or servicing.



- Turn off the power supply and unplug if the unit is not used for a long period of time.

- This air conditioner is equipped with a built-in surge protective device. However, in order to further protect your air conditioner from being damaged by abnormally strong lightning activity, you may want to disconnect it from the power supply. Do not touch the air conditioner during lightning, it may cause electric shock.

Outdoor Unit



- Do not sit, step or place anything on the unit.



- Do not touch the sharp aluminium fin.



- Ensure that the drainage pipe is connected properly. Otherwise, leakage may occur.
- After long periods of use, make sure the installation rack is not damaged.

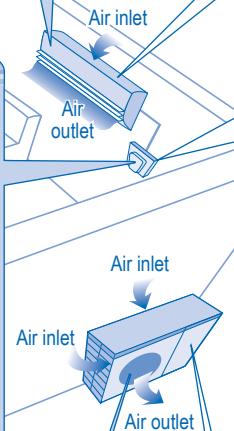

REGULATORY INFORMATION

Thank you for purchasing
Panasonic Air Conditioner

The appliance is not intended for use by young children or the infirm person without supervision. Young children should be supervised to ensure that they do not play with the appliance.

OPERATION CONDITION

Use this air conditioner under the following temperature range

Temperature (°C)		Indoor		Outdoor	
		*DBT	*WBT	*DBT	*WBT
COOLING	Maximum	32	23	43	26
	Minimum	16	11	-15	-
HEATING	Maximum	30	-	24	18
	Minimum	16	-	-15	-

*DBT: Dry bulb temperature

*WBT: Wet bulb temperature

- NOTICE:**
- This unit is still able to operate as a cooler with outdoor temperature as low as -15°C in a non-living room, such as a computer room, with a room temperature of 16°C or above, and room humidity up to 80%. When the outdoor temperature drops to -15°C, compressor will be cut off and resume operation again once the temperature rises to more than -15°C.
 - When the outdoor temperature is out of the above temperature range, the heating capacity will drop significantly and outdoor unit might stop for protection control.

Replacement or installation of power plugs shall be performed by authorized/qualified personnel only. The wires in this mains lead are coloured in accordance with the following code:

Terminals	wires	colours (GB Standard)
L	Red	live
N	Black	neutral
E	Green/Yellow	earth
		blue
		green-yellow

Wiring colour may vary depending on a country wiring code's standard.

TABLE OF CONTENTS

SAFETY PRECAUTIONS	2
REGULATORY INFORMATION	3
PRODUCT OVERVIEW & OPERATIONS	4-5
CARE & CLEANING	6
TROUBLESHOOTING	7
QUICK GUIDE	
BACK COVER	

NOTE :

The illustrations in this manual are for explanation purposes only and may differ from the actual unit. It is subjected to change without notice for future improvement.



ENVIRONMENTAL REQUIREMENTS

Battery Disposal

The batteries must be recycled or disposed of properly.



END-OF-LIFE DISPOSAL

"Instructions for end-user" for air conditioners:

This air conditioner bears the above mark, indicating that electrical equipment should not be disposed of alongside general household waste. European Community countries (*), should have a dedicated collection system for these products. Do not try to dismantle the system yourself as this could have harmful effects on your health and on the environment as a result of incorrect waste handling. This dismantling and disposal of refrigerant, oil and other parts must be done by a qualified installer in accordance with relevant local and national regulations. Air conditioners must be treated at a specialized treatment facility for re-use, recycling and recovery and should not be disposed of in the municipal waste stream. Please contact your installer, dealer or local authority for more information. Penalties may also be applicable for incorrect disposal of waste products, in accordance with national legislation.

**subject to the national law of each member state*

Information on Disposal in other countries outside the European Union

This symbol is only valid in the European Union. If you wish to discard this product, please contact your installer, dealer or local authority and ask for the correct method of disposal.

- Do not switch ON the unit when waxing the floor. After waxing, aerate the room properly before operating the unit.
- Do not install the unit in oily and smoky areas.

PRODUCT OVERVIEW & OPERATIONS

Ionizer
Do not touch during operation.

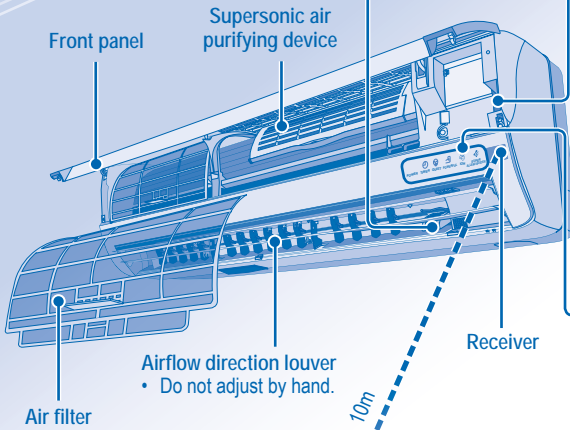

Airflow direction louver
• Do not adjust by hand.

Air filter

Maximum distances: 10m

Auto OFF/ON button

- Used when remote control is misplaced or malfunction.

Step	Action	Mode
1	Press once.	Automatic
2	Press and hold until you hear one beep, then release.	Force cooling
3	Repeat step 2. Press and hold until you hear two beeps, then release.	Normal cooling
4	Repeat step 3. Press and hold until you hear three beeps, then release.	Force heating

Press the button to turn off.

INDICATOR

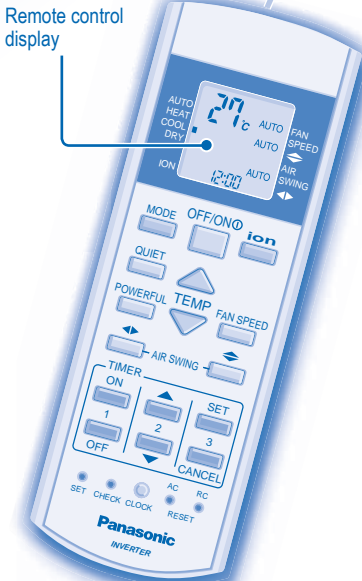
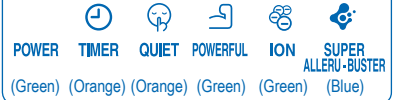

OFF/ON



TO TURN ON OR OFF THE UNIT

- Please be aware of the OFF indication on the remote control display to prevent the unit from starting/stopping improperly.



TO SET TEMPERATURE

- Selection range: 16°C ~ 30°C.
- Operating the unit within the recommended temperature could induce energy saving.
HEAT mode : 20°C ~ 24°C.
COOL mode : 26°C ~ 28°C.
DRY mode : 1°C ~ 2°C lower than room temperature.



TO SELECT OPERATION MODE

AUTO mode - For your convenience

- Unit selects operation mode every 30 minutes according to temperature setting, outdoor and room temperature. During operation mode selection the power indicator blinks.

HEAT mode - To enjoy warm air

- Unit takes a while to warm up. The power indicator blinks during this operation.

COOL mode - To enjoy cool air

DRY mode - To dehumidify the environment

- Unit operates at low fan speed to give a gentle cooling operation.

FAN SPEED TO SELECT FAN SPEED (5 OPTIONS)



- For AUTO, the indoor fan speed is automatically adjusted according to the operation mode.

AIR SWING TO ADJUST AIRFLOW DIRECTION (5 OPTIONS)



- Keeps the room ventilated.
- If AUTO is set, the louvers swing left/right and up/down automatically.
- In heat mode, the air blows horizontally for a while, then starts to blow downwards and the airflow louvers start to swing left/right after the temperature rises.

ION TO ENJOY CLEAN AIR



- To provide fresh air effect by producing negative ions.
- Ion operation could be activated independently.

Press  to stop the operation.

QUIET TO ENJOY QUIET ENVIRONMENT







- This operation reduces airflow noise.

POWERFUL TO ACHIEVE TEMPERATURE QUICKLY



- Supersonic air purifying device (super alleru-buster) operates automatically once the unit is switched on.

   can be activated in all modes and can be cancelled by pressing the respective button again.

 and  can not be selected at the same time.

TO SET THE TIMER

- To turn ON or OFF the unit at a preset time.





Select ON or OFF timer.



Set the time.



Confirm.

- To cancel ON or OFF timer, press  or  then press .

- When ON Timer is set, the unit may start earlier (up to 30 minutes) before the actual set time in order to achieve the desired temperature on time.
- Timer operation is based on the clock set in the remote control and repeats daily once set. For clock setting, please refer to Remote Control Preparation at back cover.
- If timer is cancelled manually or due to power failure, you can restore the previous setting (once power is resumed) by pressing .

OPTIONAL SETTINGS



Press and hold for 5 seconds to dim or restore the unit's indicator brightness.



Press and hold for approximately 10 seconds to show temperature setting in °C or °F.



CLOCK

Press and hold for approximately 5 seconds to show 12-hour (am/pm) or 24-hour time indication.



RC
RESET

Press to restore the remote control's default setting.



AC
SET
RESET

Not used in normal operations.

Set the temperature 1°C higher in cool mode or 2°C lower in heat mode than the desired temperature to achieve a 10% power saving.

Use curtains to screen off sunlight and outdoor heat to reduce power consumption during cool mode.

CARE & CLEANING



CAUTION

- Switch off the power supply and unplug before cleaning.
- Do not touch the aluminium fin, sharp parts may cause injury.

WASHING INSTRUCTIONS

- Do not use benzene, thinner or scouring powder.
- Use only soap (\approx pH7) or neutral household detergent.
- Do not use water hotter than 40°C.

HINTS

- Clean the filter regularly for best performance and to reduce power consumption.
- Please consult your nearest dealer for seasonal inspection.

AIR FILTERS

- Air filters cleaning is needed every two weeks.
- Wash/rinse the filters gently with water to avoid damage to the filter surface.
- Dry the filters thoroughly under the shade, away from fire or direct sunlight.
- Replace any damage filter.

FRONT-PANEL

Raise and pull to remove.
Wash gently and dry.

INDOOR UNIT

Wipe the unit gently with a soft, dry cloth.

IONIZER

Clean with cotton bud.

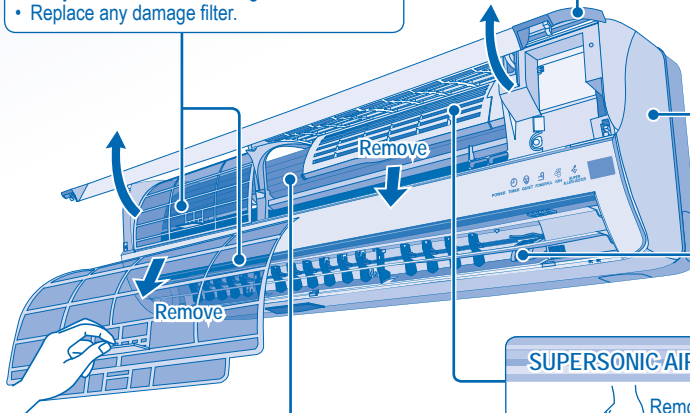

ALUMINIUM FIN

SUPERSONIC AIR PURIFYING DEVICE

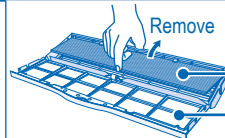

Vacuum the super alleru-buster filter.

Vacuum, wash and dry the frame.

- It is recommended to clean the filter every 6 months.
- Replace the filter every 3 years or replace any damaged filter.
Part no.: CZ-SA13P

FOR SEASONAL INSPECTION AFTER EXTENDED NON-USE

- Checking of remote control batteries.
- No obstruction at air inlet and air outlet vents.
- After 15 minutes of operation, it is normal to have the following temperature difference between air inlet and air outlet vents:
Cooling: $\geq 8^{\circ}\text{C}$ Heating: $\geq 14^{\circ}\text{C}$

FOR EXTENDED NON-USE

- Activate heat mode for 2~3 hours to thoroughly dry the unit.
- Turn off the power supply and unplug.
- Remove the remote control batteries.

NON SERVICEABLE CRITERIAS

TURN OFF POWER SUPPLY AND UNPLUG then CALL Authorized Distributor under the following conditions:

- Abnormal noise during operation.
- Water/foreign particles have entered the remote control.
- Water leaks from Indoor unit.
- Circuit breaker switches off frequently.
- Power cord becomes unnaturally warm.
- Switches or buttons are not functioning properly.

TROUBLESHOOTING

The following symptoms do not indicate malfunction.

Symptom	Cause
Mist emerges from indoor unit.	<ul style="list-style-type: none"> • Condensation effect due to cooling process.
Water flowing sound during operation.	<ul style="list-style-type: none"> • Refrigerant flow inside the unit.
The room has a peculiar odour.	<ul style="list-style-type: none"> • This may due to damp smell emitted by the wall, carpet, furniture or clothing.
Indoor fan stops occasionally during automatic fan speed setting.	<ul style="list-style-type: none"> • This helps to remove the surrounding odours.
Operation is delayed a few minutes after restart.	<ul style="list-style-type: none"> • The delay is a protection to the unit's compressor.
Outdoor unit emits water/steam.	<ul style="list-style-type: none"> • Condensation or evaporation occurs on pipes.
Timer indicator is always on.	<ul style="list-style-type: none"> • The timer setting repeats daily once set.
Power indicator blinks during operation and the indoor fan is stopped.	<ul style="list-style-type: none"> • The unit is in defrost mode, and the melted frost is drained from the outdoor unit.
Indoor fan stops occasionally during heating operation.	<ul style="list-style-type: none"> • To avoid unintended cooling effect.
Power indicator blinks before the unit is switched on.	<ul style="list-style-type: none"> • This is a preliminary step in preparation for the operation when the ON timer has been set.
Cracking sound can be heard during operation.	<ul style="list-style-type: none"> • Panel expanding/contracting due to change in temperature.

Check the following before calling for servicing.

Symptom	Check
Heating/Cooling operation is not working efficiently.	<ul style="list-style-type: none"> • Set the temperature correctly. • Close all doors and windows. • Clean or replace the filters. • Clear any obstruction at the air inlet and air outlet vents.
Noisy during operation.	<ul style="list-style-type: none"> • Check if the unit has been installed at an incline.
Remote control does not work. (Display is dim or transmission signal is weak.)	<ul style="list-style-type: none"> • Insert the batteries correctly. • Replace weak batteries.
The unit does not work.	<ul style="list-style-type: none"> • Check if the circuit breaker is tripped. • Check if timers have been set.
The unit does not receive the signal from the remote control.	<ul style="list-style-type: none"> • Make sure the receiver not obstructed. • Certain fluorescent lights may interfere with signal transmitter. Please consult your nearest dealer.
Ion indicator on the indoor unit is blinking.	<ul style="list-style-type: none"> • Press  button twice. If the indicator is still blinking, please consult the dealer.

The unit stops and the timer indicator blinks.

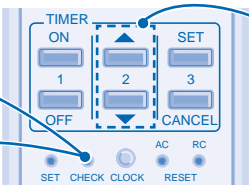

- 1 Press for 5 seconds.
- 2 Press until you hear beep sound, then jot down the error code.
- 3 Press for 5 seconds to quit checking.

- Turn the unit off and reveal the error code to your nearest dealer.

NOTE :

- The unit may be operable (with 4 beeps) on a limited basis, depending on the error.